

Building and Testing Lenticular Truss Bridge with Glass-Bundle Diagonals and Cast Glass Connections

Ate Snijder, Rob Nijssse, Christian Louter
Delft University of Technology, the Netherlands, a.h.snijder@tudelft.nl

On the campus of Delft University the Glass and Transparency Research Group is preparing to build a pedestrian bridge as a low arch consisting of dry-stacked glass blocks. As temporary support for the arch, a lens-shaped truss has been constructed and placed on location. This truss has been fitted with as many glass components as was structurally feasible. The diagonals in the truss are glass bundle struts and the nodes of the truss are cast glass components. The lenticular truss will serve as a temporary bridge during the time the team needs to prepare for construction of the eventual Glass Arch Bridge. Due to the experimental nature of the truss, with its unusual and novel applications of structural glass, a number of demonstrative proof loadings were performed to ease concerns about the safety of the structure. The glass bundles have been proof-loaded to twice their maximum expected load just prior to their installation in the structure. The whole system has then been proof-loaded for several critical load combinations (static and dynamic) just after installation. During the proof-loading the strains in the glass diagonals have been measured. These lie easily within the acceptable limits. In the paper the structural design of the bridge, in particular the glass node connector and the glass bundle diagonals will be explained. Then the proof-loading of the bridge will be described. Then the results of the proof-loading are presented and discussed.

Keywords: Glass, bridge, proof-loading, truss

1. General

The 'Glass Truss Bridge' serves as a temporary bridge, until the 'Glass Arch Bridge' will take its place. It also serves as the 'scaffolding' needed to construct the glass arch. The arch consists of dry stacked glass blocks which will only function structurally when the last block has been placed and the scaffolding has been removed. Only then will occur the stabilizing compressive force in the 40 cm thick solid glass blocks.



Fig. 1 artist impression of the final 'Glass Block Arch Bridge'.

For the temporary 'Glass Truss Bridge' it has been attempted to create as efficient a truss shape as possible. The form of the top chord of the truss follows the shape of the future 'Glass Arch Bridge'; it will support the glass blocks during the construction of the final glass block arch bridge. This way the lens shape of the truss is created. Large structural depth in the middle of the span and smaller at the supports, conforming to the magnitude of the bending moment. At the supports however, sufficient shear capacity must be ensured.



Fig. 2 photo of the glass truss bridge.

A stiff design has been chosen because of the magnitude of the loads. The glass blocks that will later be stacked on the current ‘scaffolding’-bridge represent a load of 12 kN/m^2 and the live load for the bridge is 5 kN/m^2 . For a span of 14 meters this amount to a structural depth of the truss of $14/10=1.4 \text{ m}$. In order to keep pushing the boundaries of the state of the art, the design team chose to use glass diagonals for the truss. Building Technology PhD Faidra Oikonomopoulou, has investigated ways to make a safe all-glass column (Oikonomopoulou, van den Broek, Bristogianni, Veer, & Nijse, 2017), so why not adapt this principle to make glass diagonals for the truss? Glass and compression are affiliated, and because of the concept of making a bundle of glass rods, the diagonal can be considered more or less robust as well (against vandalism). The design team wanted a Warren-truss though, with diagonals in the shape of a ‘W’. This means that the diagonals will be subjected to compressive and tensile forces alternatively.

The team did not want to be pressured in terms of time and finances by producers of the glass blocks (there aren’t many that can do it), so a temporary bridge deck was conceived. The Green Village, the area and organization to which the bridge provides access, has as their mission to promote sustainability. To convey this mission the bridge deck has been fitted with soil, grass and pavers. The two lens shaped trusses are placed next to each other with on top corrugated steel sheeting cantilevering by $1/3^{\text{rd}}$ of the span to each side, guaranteeing a minimum of deflection. For service as a temporary bridge the deck of soil, grass and pavers weighs around 500 kg/m^2 and is contained by two retaining walls made by laminated 50 cm tall glass panes which are fixed to the corrugated steel plates at two heights so they are clamped at the bottom. Through the glass the soil, grass and roots can be seen.

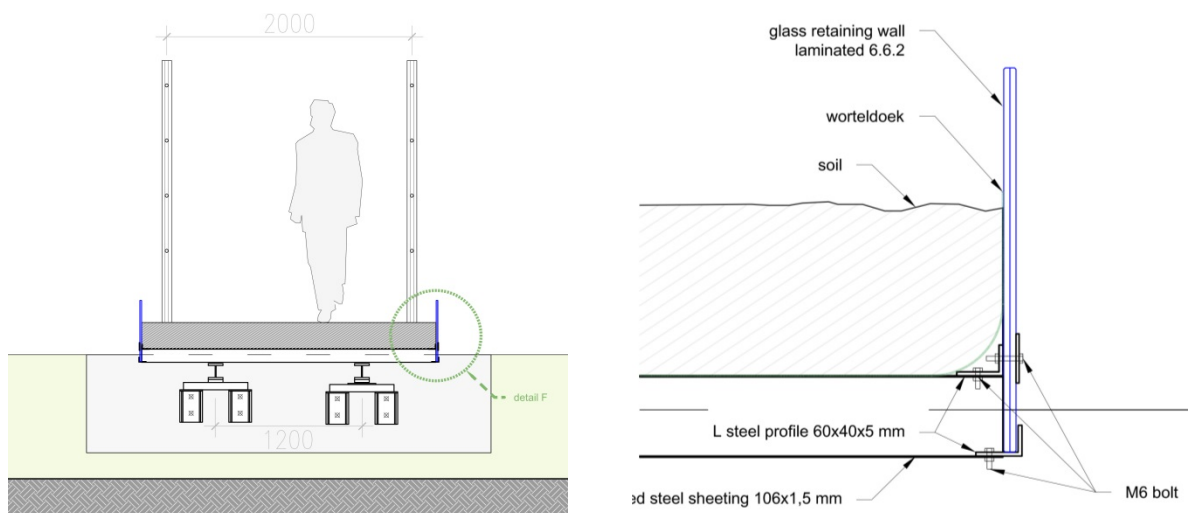

Fig. 3 section of the glass truss bridge with detail of glass retaining wall.

Building and Testing Lenticular Truss Bridge with Glass-Bundle Diagonals and Cast Glass Connections.

When the 'Glass Arch Bridge' will be constructed, the glass blocks will be placed on top of this steel sheeting. When the arch is complete, the trusses (scaffolding) will be jacked up a minimum amount (3-5 mm) and the supports for the trusses will be removed (specially design steel brackets allow for easy removal). The trusses can then be lowered by the jacks in a controlled manner until the whole of the centering is removed. They can then be used elsewhere as a bridge.



Fig. 4 Photo of detail of the glass truss bridge showing deck.

2. Design and Build of the Glass bundle diagonals.

'For every structural application it holds that the component should be able to withstand the lunatic with the hammer', is what we teach our students. Cracking, even crushing of part of the component is allowed, but must not lead to its complete collapse. We strive for ductile behaviour, not brittle. Also, according to the Eurocodes, a loadbearing structure must be robust; a component may fail without causing progressive collapse. All these principles apply to the glass diagonals consisting of 6 rods around a central hollow star-shaped rod, bonded together to form a bundle.

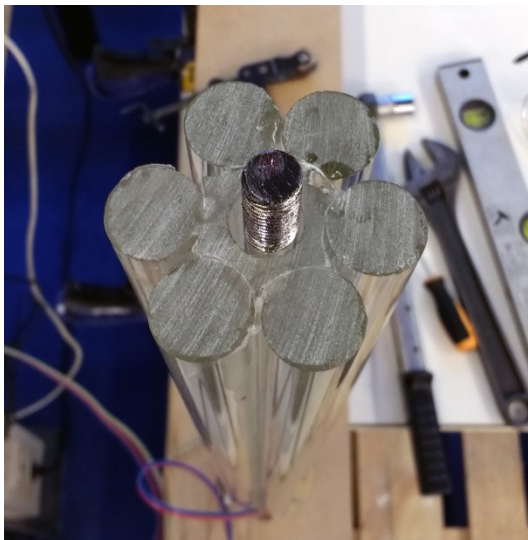

bundle of 6 x 22mm diameter glass rods, bonded with DELO around startshaped hollow profile

12 mm diameter steel rod
S355, chromed

3 mm of air between glass
and steel rod.

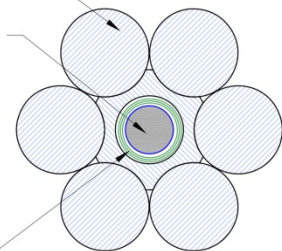

Fig. 5 and 6 showing the cross section of the bundles

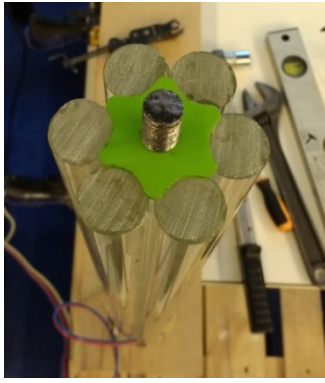

Fig. 7 steel pre-tension rod and plate centering

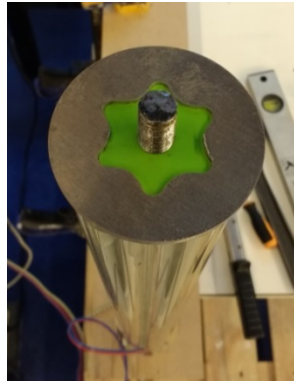

Fig. 8 Soft Aluminium cap to avoid peak stresses

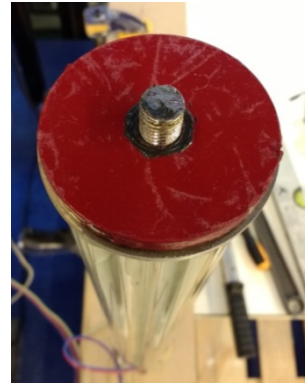

Fig. 9 Steel ring to spread load



Fig. 10 extension nut to apply pre-stress

‘The Lunatic with the hammer’ can break one, two, maybe three glass rods, but wiping out the complete bundle would require too much time and effort. In the structural calculations the scenario with one diagonal missing has been checked, and in terms of stresses still proved to be acceptable, although deformation increases dramatically. Only the removal of the diagonal next to the support is problematic: the shear next to the support results in very large deformation. This is why, next to the supports, the diagonals are steel square hollow sections.

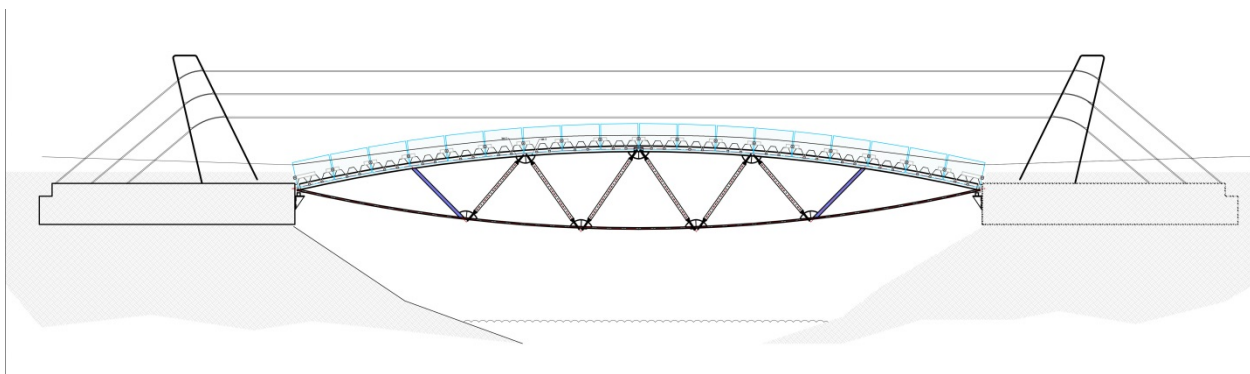

Fig. 11 drawing of the glass truss bridge in elevation. Note that the left-most and right-most diagonals are steel.

Students from the minor ‘Bend and Break’ (3rd year Civil Engineering students) build structural components (in timber, concrete, steel and masonry) and subsequently load them until failure. This to teach the students that constructing is a profession which determines to a large extent the ultimate strength of a structure and that ultimate strength is not a single value but a range. To these students the assignment was given to make, in the 2nd quarter of academic year 2016/2017, the glass bundle columns, identical to the ones to be used in the bridge. See table 1 for results of the proof loading of these columns.

Table 1: Result of proof loading individual glass bundles

Length [mm] (4 specimens per length)	Max compression expected according to model [kN]	Pre-stress already applied in specimen [kN]	Compressive force in proof loading [kN] (excluding prestress)	Stress in glass [N/mm ²] Including prestress
1251 (A and F)	23.7	17.2	47.4	25.3
1339 (B and E)	19.5	18.8	39.0	22.7
1408 (C and D)	19.5	16.6	39.0	21.8

Twelve columns were produced and tested. The load during the test was twice the maximum expected load in the bridge, in accordance with E997-15. This load was maintained for ten minutes. A few of the bundles showed signs of partial failure, chipping or cracks and were discarded.



Fig. 12 Test setup



Fig. 13,14,15 Hydraulic piston, force gauge, ball joint.



Each of the columns that were tested were fitted with strain gauges on three sides. Fig. 11 indicates their placement on the bundle. The strain gauges were originally fitted to record the strain in the glass while applying the pre-stress, but were also read out during the proofloading. The graph in Fig.12 shows typical strain force relation observed in all the satisfactorily proof loaded bundles. There is some plastic deformation in the setup. This is most likely the 4mm soft aluminium cap, see Fig. 8.

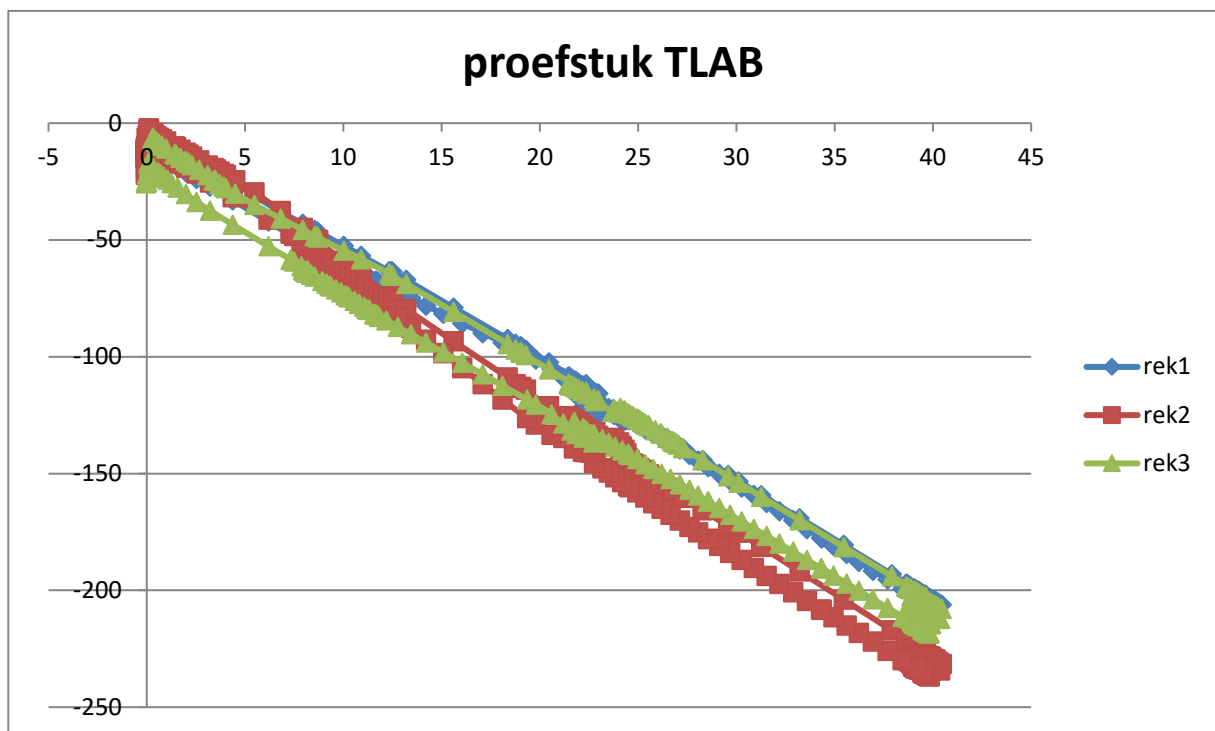

Fig. 16 The strain (vertical axis) recorded by three strain gauges plotted against force (horizontal axis) recorded by the force gauge.

To allow the diagonals to take tensile forces without actually introducing tensile stresses in the glass, a steel 12mm diameter rod is placed in the hollow central channel of the star shaped glass profile. By pre-tensioning the steel rod, a constant compressive stress is introduced in the glass, and tensile forces in the diagonal would not lead to tensile stresses in the glass. This central steel rod also solved issues in the design of the connection. A simple extended nut makes the connection between the glass diagonal and the top or bottom chord of the truss (figs 17 and 18). The only downside was the black line visible in the middle of the glass bundle. Until someone suggested to give the tendon a reflective chrome coating, which made the steel virtually invisible in the glass diagonal. All the pre-stressed glass diagonals, twelve in total, have been tested until twice their maximum expected load. They all survived.

3. Details of nodes and supports

Two central questions are: how to connect the top and bottom chords to the diagonals and how to transfer the shear force from the truss into the support/foundation? In the Stevin-II laboratory many possibilities have been investigated to transfer a large compressive force into a glass bundle without irregularities or contaminants in the contact area between glass and steel causing premature cracking of the glass. Not all the rods will have exactly the same length. This effect too, will have to be solved in the detailing. The experiments showed that soft aluminum (which was also heated and cooled slowly to remove residual stresses from the material) was best suited as interface at the contact surface between steel and glass.

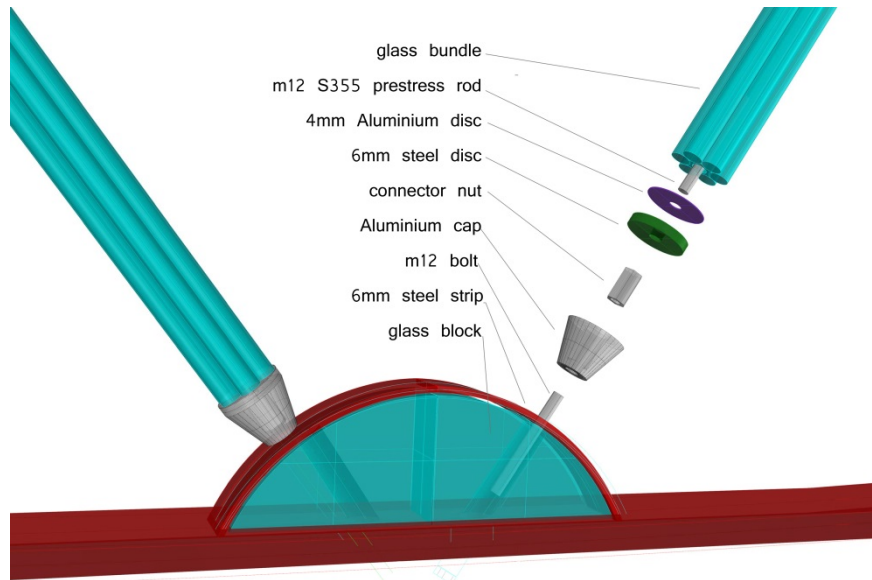

Fig. 17 Showing end solution for the glass diagonal.

An aluminum head in the shape of a truncated cone is placed at the ends of the diagonals. The surface area of the truncated end of the cone is as small as the stresses allow. This means the diagonal can still freely rotate around the node, ensuring that the critical buckling length is equal the length of the diagonal and without bending moments that would result from a fixed connection. We could have placed the ends of two diagonals, that come together at a single node, on as small a steel node possible. However, we wanted to again apply glass to 'lighten' the node. Some studies were done on a completely cast glass node, but in the fast-paced design and build trajectory we could not take enough time to properly engineer the node. In the end a 6 mm thick steel strip is curved around two waterjet cut glass blocks (left-over from the Crystal houses project in Amsterdam) and bonded with double sided acrylate tape. Here again; the solution works well in compression, but in tension? A truss with diagonals in a 'W' configuration will be subjected to tensile forces as well. By extending the pre-stress tendon in the diagonal with an extension nut and cutting a hole through the solid glass block, we could connect the diagonal directly to the top and bottom chords of the truss through the steel.

Building and Testing Lenticular Truss Bridge with Glass-Bundle Diagonals and Cast Glass Connections.

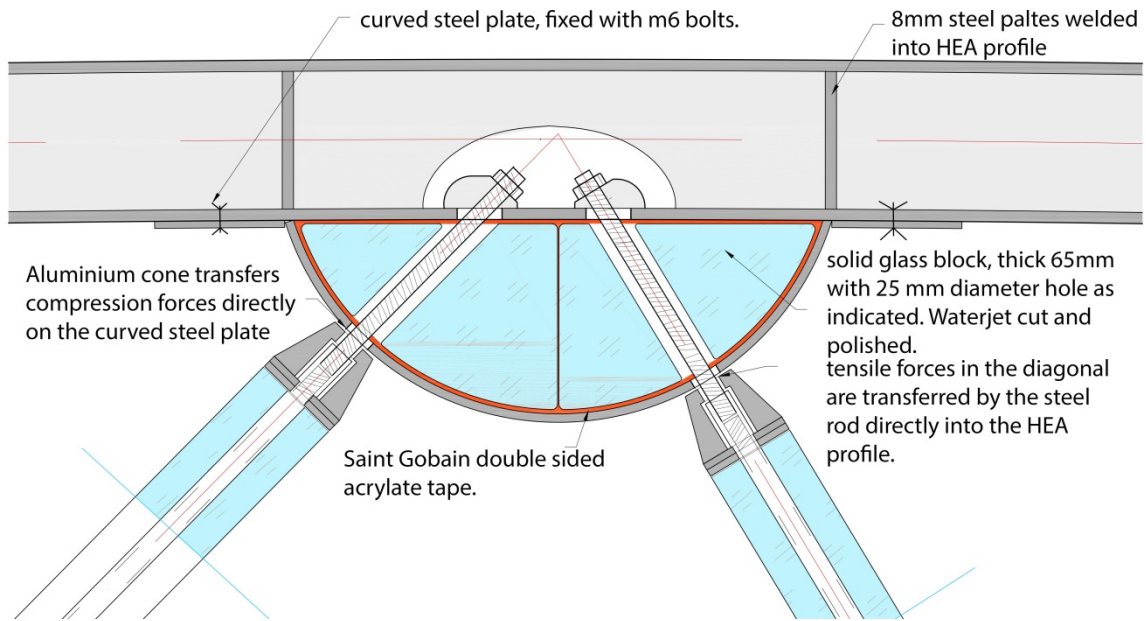

Fig. 18 Drawing showing complete connection detail of diagonal to node.

At the support the large loads lead to large reaction forces. Because a lens-shaped truss ends in a point, the shear capacity becomes critical. It was decided to weld extra steel plates in the plane of the web of the steel HEA profile between the top and bottom chords. This showed to be effective in terms of stresses and deformation.



Fig. 19 Photo of node.

4. Structural Analysis

A distributed live load of 5 kN/m^2 or two loads of 80 kN and 40 kN representing an emergency vehicle has been applied, according to NEN-EN 1991-2. A horizontal load of ten percent of the live load has been assumed to act along the long axis of the bridge. The consequence class for the bridge was CC1 and the reliability class RC1. The bridge is temporary: <10 year.

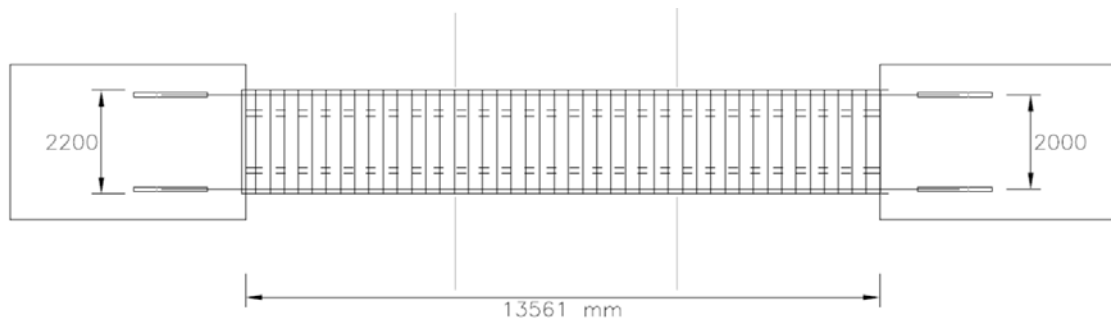

Fig. 20 Plan view bridge.

The calculation has been done in DIANA finite element analysis using truss elements for the glass diagonals and beam elements for the top and bottom chords of the truss. The following four loadcases have been checked:

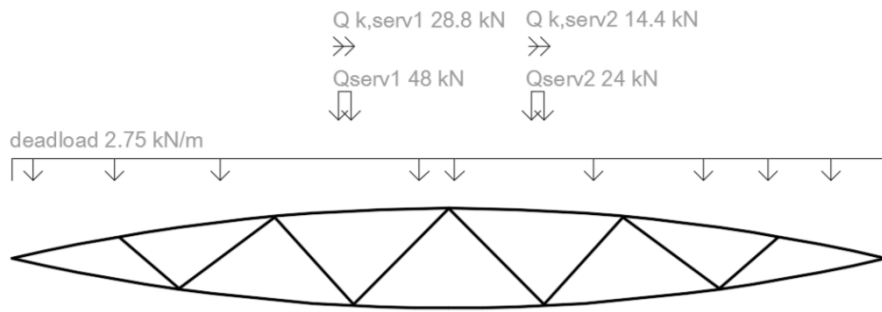

Fig. 21 Load Case 1; vehicle.

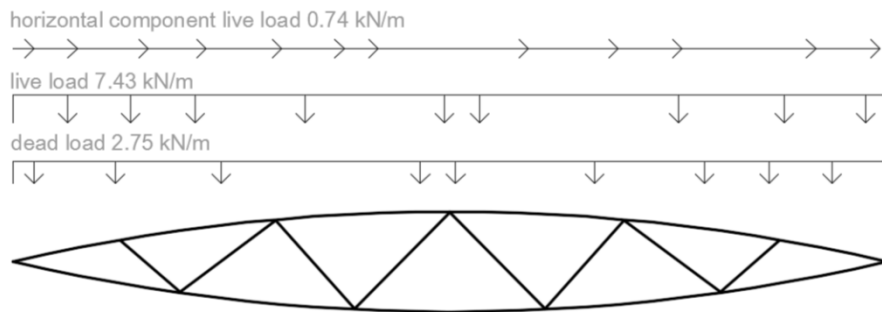

Fig. 22 Load Case 2; crowd.

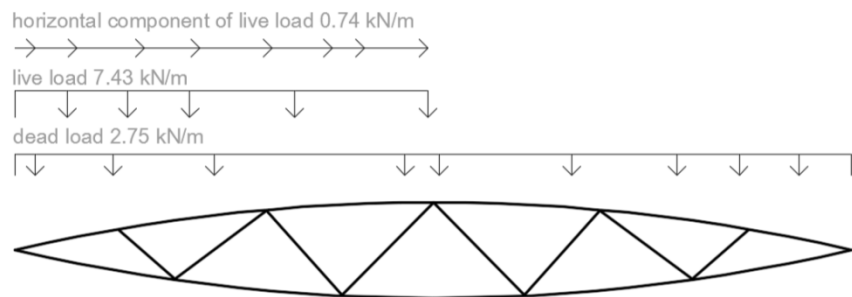

Fig. 23 Load Case 3; asymmetric load crowd.

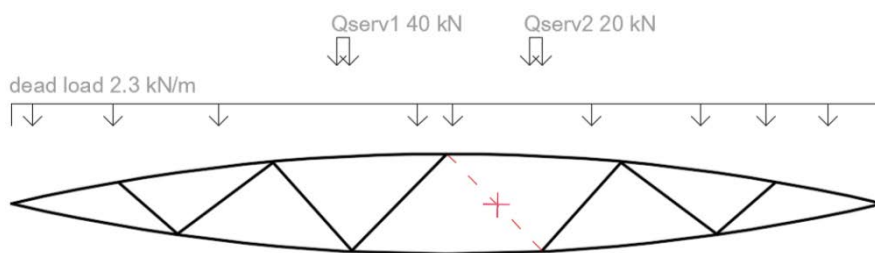

Fig. 24 Load Case 4; vehicle and one diagonal collapsed.

Building and Testing Lenticular Truss Bridge with Glass-Bundle Diagonals and Cast Glass Connections.

Results Servicability limit state:

- Loadcase 1: max vertical deflection 21.0mm
- Loadcase 2: max vertical deflection 25.5mm
- Loadcase 3: max vertical deflection 25.6mm
- Loadcase 4: max vertical deflection 38.1mm

Results Ultimate Limit state, Axial forces in glass diagonals:

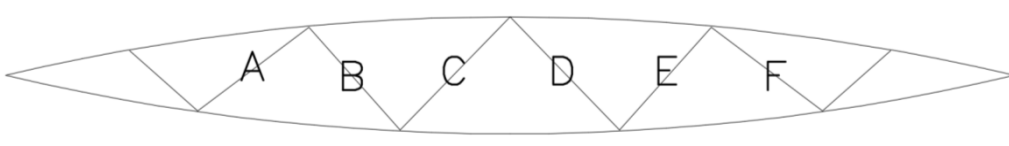

Fig. 25 Letters assigned to diagonals.

Rod	LC1 [kN]	LC2 [kN]	LC3 [kN]	LC4 [kN]
<i>Glass Diagonal</i>				
A	-10.4	-2.23	-31.3	-26.3
B	-5.29	-16.9	-11.2	-17.0
C	-7.51	+7.69	-2.88	+3.56
D	-8.49	-18.2	-26.0	X
E	-4.19	+11.1	+13.4	-9.82
F	-11.2	-11.5	-27.8	-31.6
Vert. support reaction left	69.2	57.0	51.4	48
Vert. support reaction right	70.0	31.9	51.1	43.5
Hor. Support reaction	10.1	5.11	39.0	0

The largest (tension) normal force in the diagonals is 13.4 kN. In response a minimum of 16 kN of prestress was applied to the glass diagonals. If we add up the largest tension force and the prestressing force (conservevative method) the result is a maximum tensile force of 29.4 kN. For this a S355 steel rod of 12 mm diameter is used. The utilization of the rod is then $(29400 / \pi \cdot 6^2) / 355 = 0.732$.

For the compressive strength of the glass 20 MPa has been assumed. The largest compression for is 31.6 kN. When the prestress is simply added (conservative assumption) then the total compression is 47.6 kN. The cros sectional area of the glass rods is 2552 mm². The utilization of the glass diagonal under compression is: $(47600 / 2552) / 20 = 0.93$.

Buckling

The table shows the largest compression force that can occur in a diagonal, including the pretension force, Eulers critical buckling force per bundle and the factor that relates the two.

bundle	Length [mm]	Eulers critical buckling force [kN]	Largest compression force [kN]	Factor [-]
<i>Diagonals</i>				
A	1325	251	-47.3	5.31
B	1472	203	-33.0	6.15
C	1543	185	-23.5	7.87
D	1543	185	-42.0	4.4
E	1472	203	-25.8	7.86
F	1325	251	-47.6	5.27

5. Realistic proof loading.

In addition to extensive computer modeling, in which the collapse of one of the diagonals has been simulated, and the proof-loading of the individual glass bundles in the Stevin-II laboratory, it was decided to also proofload the entire bridge as constructed in its final configuration. For this, we called in 60 TU Delft students. Thirty from the faculty of Architecture and thirty from the faculty of Civil Engineering. They were the literal live load and we asked them to perform different static loading configurations and dynamic ones too.

The students were each weighed at the beginning of the test. This resulted in an average mass of 73.5 kg per student. For the various loadcases the students have been counted and multiplied by this number to obtain the total load. Then divided by half of the width of the bridge (2 m) and the length of the span (13.6m) to get to the distributed load in kN/m.

Each diagonal has been fitted with three strain gauges. Using the mean strain, $E=63\,000\text{ N/mm}^2$ and $A=2551\text{ mm}^2$ the force in the diagonals was computed.

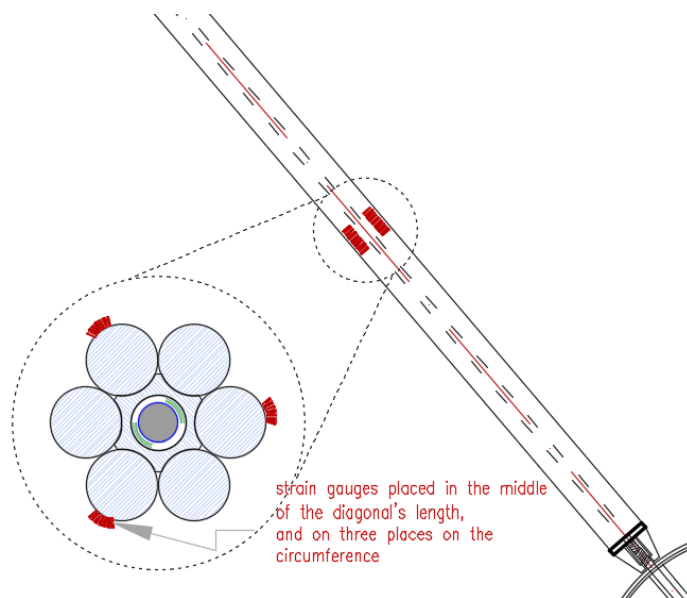

Fig. 26 strain gauges placement on glass diagonals of the bridge.

6. Loadcases

6.1. Loadcase 1: fully loaded with 67 students.

The distributed load on the measured truss is approximately 1.81 kN/m.



Fig. 27 load case 1. 67 students; approx. 1.81 kN/m

Building and Testing Lenticular Truss Bridge with Glass-Bundle Diagonals and Cast Glass Connections.

6.2. Loadcase 2: asymmetric load with 39 students.

The distributed load is approximately 2.11 kN/m on half the span.



Fig. 28 Loadcase 2. Asymmetric load with 39 students; approx. 2.11 kN/m

6.3. Loadcase 3: 60 running students.

Only 20 students are on the bridge at one time, corresponding to a mass of $20 \times 0.735 = 14.7$ kN.



Fig. 29 Loadcase 3. Jogging students

6.4. Loadcase 4: 60 marching students.

The marching students were packed more closely together and all 60 were on the bridge at the same time, as can be observed in the photo.



Fig. 30 Loadcase 4. 60 Marching students

6.5. Loadcase 5: 60 dancing students.

30 students on the bridge at one time. Corresponding to a mass of $30 \times 0.735 = 22.05$ kN.



Fig. 31 Loadcase 5. Dancing students

7. Results and discussion

Table 2: showing forces in the diagonals for the different loading scenarios

Force [kN]	A	B	C	D	E	F	
LC 1 = fully loaded	-2.36	-0.94	-1.39	-0.99	-1.23	-2.21	
LC 2 = half loaded	1.59	1.92	-0.21	2.52	-0.92	2.34	
LC 3 = running	Min	-1.80	-2.04	-1.55	-1.50	-1.40	-2.02
	max	1.06	1.05	1.47	1.05	0.99	0.61
LC 4 = marching	Min	-3.42	-2.62	-3.43	-2.66	-2.89	-3.98
	max	1.82	2.52	1.76	2.24	1.65	1.78
LC 5 = dancing	Min	-3.95	-2.13	-3.36	-2.02	-2.68	-3.66
	max	0.82	1.82	1.06	1.14	1.07	1.00

Red shows highest tension force , Green shows highest compression force.

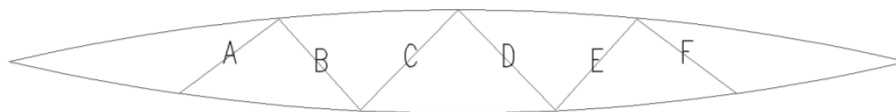

Fig. 32 Letters assigned to the diagonals for reading results.

The most critical loading scenario was LC 4; the marching students. Two possible explanations: 1. The load is dynamic, each step exerts a larger downward force than just the student’s weight because of momentum. 2. This effect is also present in the running and especially the dancing students, LC 3 and LC 5. However, in these load cases the students were much further apart and at anytime only 20 or 30 students were on the bridge deck. In the case of the marching students they were able to walk in close formation and all 60 were on the bridge.

It makes sense that the highest tension forces occurred in the diagonals during the asymmetric loading. The numerical and analytical study prior to the test already showed that this loading scenario would be most critical for tension.

8. Conclusions

In all loading scenarios, even the most critical scenario with the marching students, the utilization of the diagonals was low. The highest compressive force was 3.98 kN. This diagonal has been proof loaded in the lab to 47.4 kN, twice the maximum expected load of 23.7 kN. So we only managed to get to 16.8% of the maximum expected load. When the glass blocks are laid during the construction of the Glass Arch Bridge the utilization will be higher.

Building and Testing Lenticular Truss Bridge with Glass-Bundle Diagonals and Cast Glass Connections.

It was physically not possible to create a static live load of 5 kN/m². However, if we consider the load effect of dynamic loading of the marching students on the force in the diagonals and reverse calculate how high a static load would be required to create the same load effect then we get close: approximately 3 kN/m².

Acknowledgements

DIMI (Delft Delta's, Infrastructures & Mobility Institute) has sponsored the research and construction of the bridge.

The firm ZWATRA transport has sponsored transport of the bridge from the Stevin II lab and placement on site.

The Green Village has provided location for the bridge and provided the abutments.

Hovenier van der Heijden has created the landscaped deck of the bridge at discounted rate.

Students from the minor Bend and Break have created the glass diagonals.

References

Oikonomopoulou, F., van den Broek, E. A. M., Bristogianni, T., Veer, F. A., & Nijse, R. (2017). Design and experimental testing of the bundled glass column. *Glass Structures & Engineering*, 2(2), 183-200. doi:10.1007/s40940-017-0041-x

